

## BLANK ROLLING SHUTTERS P.115

### Description

The rolling shutter is composed by blank, single-sheet slats 115mm high, in galvanized steel or aluminium.

Vertical motion with upper roll-up.

Bottom slat height 140 mm with handle and gasket.

It can be endowed with wind-proof system, noiseless system, insertion of elements for the airing and rectangular visual panels in plexiglass.

In compliance with the standard UNI EN 13241-1 **CE**

The rolling shutters installed in façade, exposed to wind, must be CLASS 2 in compliance with standard EN 12424.

### Technical specifications

Material	Galvanized steel	Galvanized steel	Aluminium	Aluminium	Stainless steel AISI 316
Thickness [mm]	0,8	1,2	1,0	1,2	0,8
Weight [kg/m <sup>2</sup> ]	10,70	13,40	4,50	5,30	10,70
Max Width [m]	15,00	15,00	5,00	5,00	15,00
Wind resistance Class 2 <sup>(1)</sup> up to L x H	5000x2000	6500x2000	-	-	5000x2000
Application	Garages - Shops - Various				

1. Obtainable without tear-proof brackets.

### Dimensions

The values are approximates. For specific details contact our Technical Department.

In case of rotating shaft the minimum vertical space is 500 mm (motor + supports).

In case of galvanized steel, thickness 0,8 mm or stainless steel AISI 316, thickness 0,8 mm with spring or octagonal shaft  $\varnothing 70$ , look at the table below; for spaces related to other thickness or material please contact our Technical Department.

H Height	B - Roll Diameter (mm)																					
	Spring-loaded shaft										Octagonal shaft $\varnothing 70$ with adapter $\varnothing 180$											
6000	385	385	385	410	410	410	-	-	-	-	-	-	-	-	385	-	-	-	-	-	-	
5500	370	370	370	400	400	400	400	-	-	-	-	-	-	-	370	370	-	-	-	-	-	
5000	355	355	355	355	390	390	390	390	-	-	-	-	-	-	355	355	-	-	-	-	-	
4500	350	350	350	350	370	370	370	370	370	-	-	-	-	-	350	350	-	-	-	-	-	
4000	340	340	340	340	340	360	360	360	360	360	360	-	-	-	340	340	340	-	-	-	-	
3500	330	330	330	330	330	330	355	355	355	355	355	355	365	-	330	330	330	330	-	-	-	
3000	320	320	320	320	320	320	345	345	345	345	345	345	345	355	320	320	320	320	-	-	-	
2500	300	300	300	300	300	300	330	330	330	330	330	330	330	330	300	300	300	300	300	-	-	
2000	290	290	290	290	290	290	315	315	315	315	315	315	315	315	290	290	290	290	290	290	-	
	1500	2000	2500	3000	3500	4000	4500	5000	5500	6000	6500	6750	7000	7500	1500	2000	2500	3000	3500	4000	4500	5000
	L – Length of the opening																					

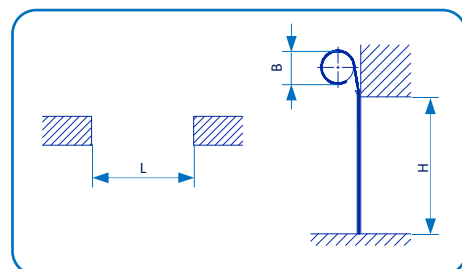
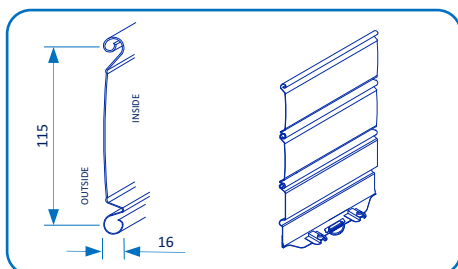

Note: with lateral stoppers installation, the roll diameter (B) in green have to be increased of 15%, while the measures highlighted in yellow and red have to be increased of 10%.

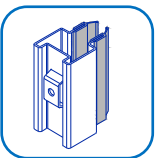
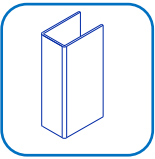
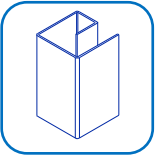

## Lateral guides

<p>Shaped guides in galvanized steel, thickness 2,0 mm with PVC gasket. For installation within and behind the opening</p>	
<p>“U” shaped guides in galvanized steel, thickness 1,5 mm - 30 x 22 x 30 for widths until 2500 mm - 40 x 22 x 40 for widths until 4400 mm - 40 x 25 x 40 for widths until 4400 mm - 50 x 25 x 50 for widths until 5600 mm - 70 x 27 x 70 for widths until 7500 mm</p>	
<p>“G” shaped guides in galvanized steel, thickness 2,0 mm - 60 x 60 – 80 x 60 – 80 x 80 – 100 x 80 - for rolling shutters with roll diameter higher than 450 mm - for installation behind the opening - for wind-proof and/or tear proof</p>	

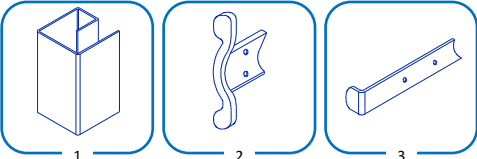
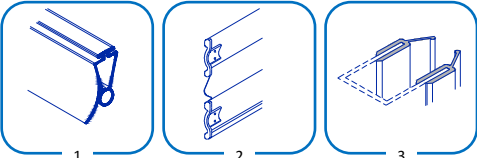
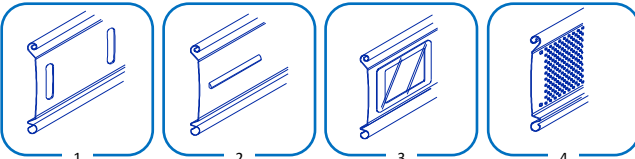
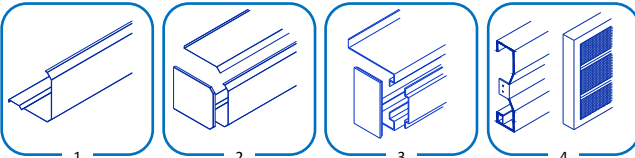







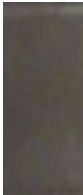

## Accessories

<b>Wind resistance and tear-proof devices</b>	
<p>Kit for certified product or for use in windy areas, supplied with:</p> <ol style="list-style-type: none"> <li>1. “G” shaped guides</li> <li>2. Lateral slat-stoppers</li> <li>3. Tear-proof brackets</li> </ol>	
<b>Noise reduction devices</b>	
<ol style="list-style-type: none"> <li>1. Rubber gasket applied to the bottom slat</li> <li>2. Lateral slat-stoppers in nylon</li> <li>3. PVC gaskets</li> </ol>	
<b>Aeration devices</b>	
<ol style="list-style-type: none"> <li>1. Slats with slots 50x12mm (ventilation 50 cm<sup>2</sup>/mt)</li> <li>2. Slats with hidden slots 85x5mm (ventilation 20 cm<sup>2</sup>/mt)</li> <li>3. Rectangular opening 100x50mm with or without plexiglass</li> <li>4. Micro-perforated slat in galvanized steel with holes <math>\varnothing</math> 4mm</li> </ol>	
<b>Casing</b>	
<ol style="list-style-type: none"> <li>1. Front panel</li> <li>2. Carter composed by front panel, front upper and pair carter clips</li> <li>3. Carter with removable front panel</li> <li>4. External lid in galvanized</li> </ol>	
<b>Automation</b>	
<ol style="list-style-type: none"> <li>1. Manual operation for shaft with spring Round shaft <math>\varnothing</math> 48 – 60 – 76 – 89 – 101</li> <li>2. Manual operation with torsional spring Octagonal shaft L. 70 – 102</li> <li>3. Axial motor for shaft with spring Round shaft <math>\varnothing</math> 48 – 60 – 76 – 89 – 101</li> <li>4. Tubular motor Octagonal shaft L. 70</li> <li>5. Side motor Round shaft <math>\varnothing</math> 159 – 193 – 219 – 244 – 273 – 323 – 406</li> <li>6. Forza motor Octagonal shaft L. 70 – 102</li> </ol>	

## Painting

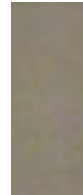
Standard painting					
1000	Green beige	7004	Signal grey	8017	Chocolate brown
1001	Beige	7016	Anthracite grey	8019	Grey brown
1013	Oyster white	7021	Black grey	8024	Beige brown
1015	Light Ivory	7024	Graphite grey	9001	Cream
6005	Moss green	7040	Window grey	9002	Grey white
6009	Fir green	7046	Telegrey 2	9005	Jet black
6015	Black olive	7047	Telegrey 4	9010	Pure white
6019	Pastel green	8004	Copper brown	9011	Graphite black
6023	Mint green	8011	Nut brown	9016	Traffic white
7000	Squirrel grey	8014	Sepia brown		
7001	Silver grey	8016	Mahogany brown		

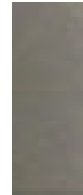
Special painting	
RAL 9006	Grey Arsonsisi
RAL colours not included in Standard painting	Metallic black
White: Marble (smooth) – Ancient marble (rough)	Black/ Brown: Sandy (rough)
Grey: Marble (smooth) - Ancient marble (rough)	Sandy 900
Brown: Marble (smooth) – Ancient Marble (rough)	Gunmetal
Green: Marble (smooth) – Ancient Marble (rough)	Gold color for external use
Red: Marble (smooth)	Hammered Brown for external use

Oxidation for aluminium rolling shutters											
											
F01	F02	F03	F04	F05	F06	F07	F08	F09	F10	F11	F12

## The complete range of rolling shutter

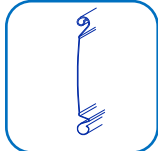

Blank P.115

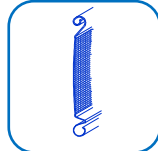

Micro-perforated P.115

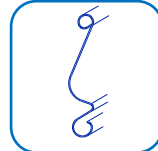

Blank P.97



Micro-perforated P.97

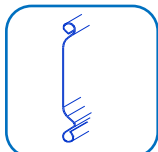

Blank P.73

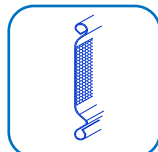

Micro-perforated P.73

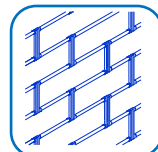

Tubular P.120

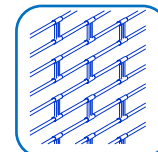

Tubular P.95

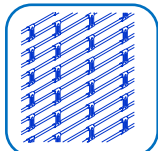

Tubular P.60

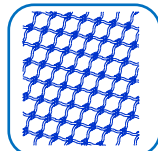

Tubonda

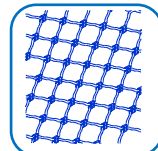

Tondino

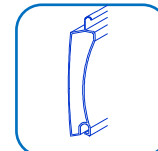

Insulated DP.77



Insulated DP.105

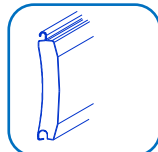

Insulated F.100

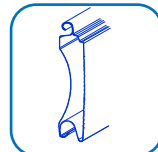

Insulated F.140

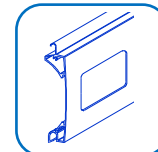

Windowed



Details and images in this leaflet are not binding.  
Conegliano Serramenti s.r.l. reserve the right to modify them without notice at any time.

### Conegliano Serramenti S.r.l

Via Campolongo 1/E Loc.Ramera Z.I. / 31010 Mareno di Piave – Treviso - Italy

Tel: +39 0438.4985 Fax: +39 0438.498540 / Web site: [www.coneglianoserramenti.it](http://www.coneglianoserramenti.it) [www.forza-motion.com](http://www.forza-motion.com)

P.I. e C.F.: 00532460268- N.Reg.Imp.di TV 8758 / Capitale Sociale i.v.: € 78.000,00 – Capitale esistente al 31.12.15 € 78.000,00i.v.